

Communications Courses

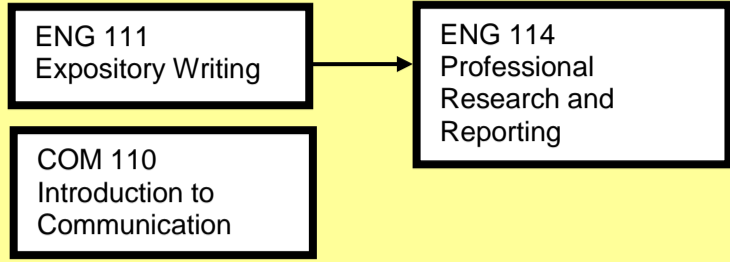

Mathematics Courses

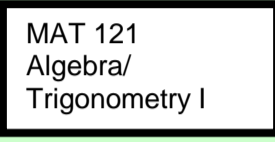

Physical & Natural Sciences

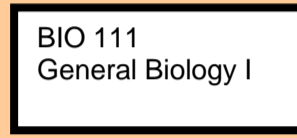

Social Sciences & Humanities

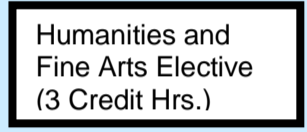
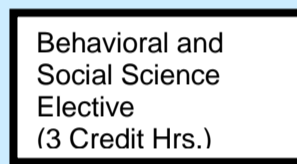

Technical Content

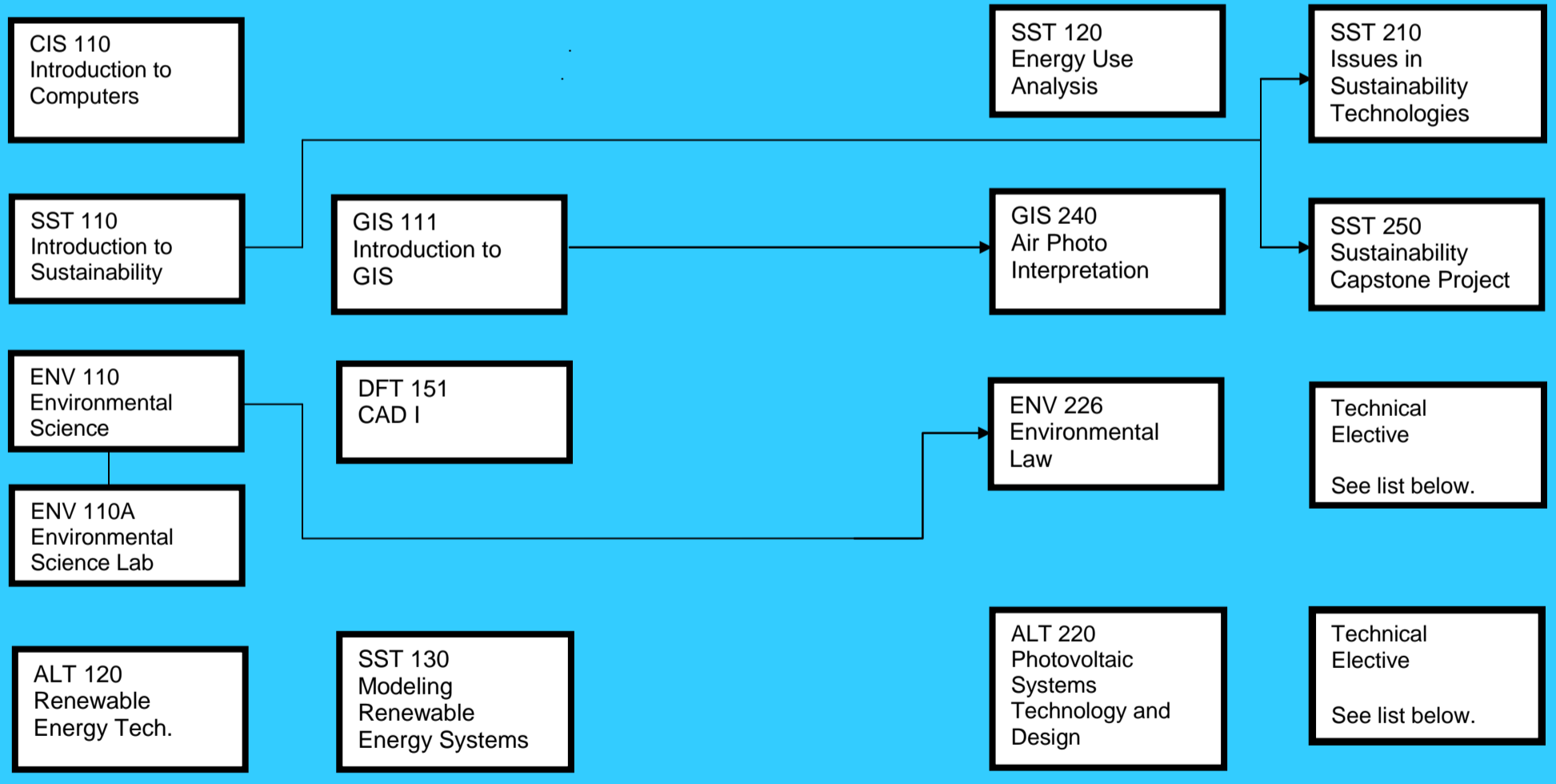

- Technical Electives**
- AHR 111 HVACR Electricity
 - AHR 112 Heating Technology
 - AHR 113 Comfort Cooling
 - ALT 110 Biofuels I
 - ALT 220 Photovoltaic Systems
 - ALT 221 Adv Photovoltaic Systems
 - ALT 240 Wind & Hydro Power Systems
 - ALT 250 Thermal Systems
 - ARC 111 Intro to Arch Technology
 - ARC 112 Construction Materials & Methods
 - ARC 210 Intro to Sustain Design
 - ARC 230 Environmental Systems
 - BIO 110 Principles of Biology
 - BIO 140 Environmental Biology
 - BIO 140A Environmental Biology Lab
 - BPR 130 Blueprint Reading/Construction
 - BUS 139 Entrepreneurship
 - BUS 230 Small Business Management
 - CAR 110 Introduction to Carpentry
 - CAR 114 Residential Bldg Codes
 - CHM 131 Introduction to Chemistry
 - CHM 131A Introduction to Chemistry Lab
 - CHM 132 Organic and Biochemistry
 - CIV 110 Statics/Strength of Mater
 - CIV 111 Soils and Foundations
 - CIV 210 Engineering Materials
 - CIV 212 Environmental Planning
 - CIV 230 Construction Estimating
 - CMT 214 Planning and Scheduling
 - CMT 216 Cost and Productivity
 - COE 112 Co-op Work Experience I
 - COE 122 Co-op Work Experience II

**Sustainability Technologies
Alternative Energy**

**CURRICULUM
(A40370)**

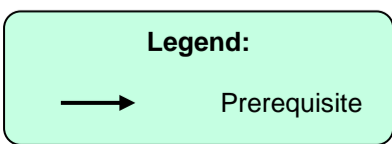

- Technical Electives**
- DBA 110 Database Concepts
 - EGR 120 Engineering and Design Graphics
 - ELC 112 DC/AC Electricity
 - ELC 113 Basic Wiring I
 - ELC 118 National Electrical Code
 - ENV 120 Earth Science
 - ENV 218 Environmental Health
 - ENV 220 Applied Ecology
 - ENV 224 Land Resource Management
 - ENV 242 Land Quality
 - GEL 120 Physical Geology
 - GEL 230 Environmental Geology
 - GEO 131 Physical Geography I
 - GIS 121 Georeferencing & Mapping
 - ISC 212 Metrology
 - LAR 111 Intro to Landscp Arc Tech
 - LAR 113 Res Landscape Design
 - LAR 120 Sustainable Development
 - MEC 111 Machine Processes I
 - MEC 161 Manufacturing Processes I
 - MEC 180 Engineering Materials
 - MEC 250 Statics and Strength of Materials
 - MEC 265 Fluid Mechanics
 - MEC 267 Thermal Systems
 - MEC 270 Machine Design
 - MEC 275 Engineering Mechanisms
 - PHY 131 Physics-Mechanics
 - PHY 132 Physics-Elec & Magnetism
 - SRV 230 Subdivision Planning
 - SRV 110 Surveying I
 - SRV 111 Surveying II